



SMS-1000

Measurement and Evaluation of

- ◆ Sparkle
- ◆ Distinctness of transmitted Image
- ◆ Reflectance Distribution Function
- ◆ Transmittance Distribution Function



- ◆ Comprehensive optical characterization of scattering Anti-Glare layers.
- ◆ Optimization of the visual performance of display systems.

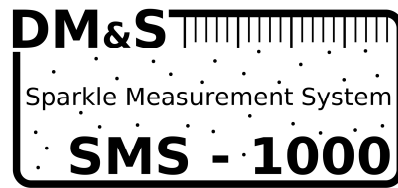

Display Ergonomics - Reduction of Glare

Reflections from ambient light sources in display screens are disturbing in at least three ways:

- ♦ they reduce contrast and color saturation of the displayed visual information,
- ♦ especially in outdoor situations they often make recognition of displayed visual information impossible (disability glare).
- ♦ in the case of mirror images of ambient light sources they may cause fusion and focusing conflicts causing headache and other adverse effects.

The amount of reflected light can be reduced and the perception of reflected images of ambient light sources can be avoided by application of scattering micro-structures to the top surface of the display screen [1, 2]. The effective reduction of glare by such scattering layers however is usually accompanied by a new unwanted effect that becomes apparent as a random pattern of small dots that change location, intensity and color with viewing direction. This disturbing effect of *visual sparkle* is recently attracting more attention due to increasing display resolution (i.e. pixel density) especially in handheld devices and more complex display systems with touch sensitive input panels. Enhanced pixel density (recently up to 500 ppi) and insertion of a touch panel that is increasing the distance between the pixel matrix of the display and the scattering anti glare (AG) layer on top of the display stack, both foster the tendency of sparkle formation in direct view displays.

Anti-glare layers, if their scattering characteristics are not properly adjusted, may also negatively affect the perception of the presented visual information by blurring of edges and small image details thus reducing the distinctness of the displayed image.

A display system with good overall ergonomic performance under a wide range of illumination conditions thus has to be optimized as follows:

- ♦ unwanted reflections have to be reduced, images of light sources have to be avoided,
- ♦ the level of sparkle has to be kept at a minimum,
- ♦ the distinctness of transmitted images has to be as high as possible.

The SMS-1000 offers a unique combination of measurements and evaluations as required for systematic optimization of visual display systems integrated in one single instrument.

- ♦ Measurement of sparkle with two methods,
- ♦ Measurement of distinctness of image (modulation transfer, Eqn. 3 in ASTM D 5767),
- ♦ Measurement of the reflectance distribution function,
- ♦ Measurement of the transmittance distribution function.

With this instrument both the manufacturer of anti-glare layers as well as the producer of special display systems (for e.g. industrial, medical and automotive applications) are able to optimize their products according to the specific requirements of their customers and the market.

[1] K. Brunnström, et al., "The effects of glossy screens on the acceptance of flat-panel displays", Journal of the SID, 16/10(2008), pp. 1041-1045

[2] Waters, et al. "Discomfort glare from sources of nonuniform luminance", J. Illuminating Eng. Soc. (1995)24, pp. 73-85

What is Sparkle?

Micro-structured scattering anti-glare layers are often used in combination with visual displays for reduction of unwanted and disturbing mirror-like reflections from ambient light sources.

Sparkle usually becomes obvious as a twinkling or glittering overlay of the image presented on display screens with scattering anti-glare cover layers, it becomes particularly distinct when the head of the observer is moving with respect to the display. Some computer users even complain about focusing problems and eye-strain caused by such visual sparkling.

Sparkle (a kind of *random moiré*) is the result of the interaction between two structured layers: the regular pixel matrix of the display and the random surface structure of the anti-glare layer.

For evaluation of the level of sparkle the intensity modulations caused by the pixel matrix of the display (regular modulations) have to be separated from the random intensity modulations that are perceived as sparkle as described in more detail below.

During the measurement of sparkle usually only the green subpixels of the display are activated because under that condition the human eye is very sensitive with respect to detection of small features.

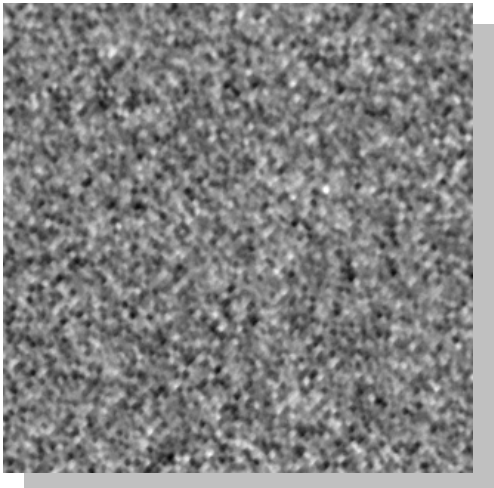

Monochromatic illumination: Sparkle is obvious as intensity modulations with random lateral distribution.



White light illumination: Sparkle is obvious as random modulations of intensity and chromaticity.

Characterization of Sparkle

A scattering anti-glare layer (glass or polymer film) is applied to a display screen with a specific pitch of the pixel matrix and an image of that combination is taken with the camera of the SMS-1000.

The recorded image is numerically low-pass filtered to account for the limited angular resolution of the human eye and to separate the display pixel modulation from the sparkle. When the anti-glare layer is not fixed to the display pixel matrix, a difference image is created from two camera exposures with a slightly translated anti-glare layer prior to application of spatial filtering (Patent DE 10 2013 011 359).

The level of sparkle is specified by the quotient of standard deviation of the gray-level distribution of the filtered image and its mean value (similar to the speckle contrast).

The imaging conditions of the standard optical system ($f = 50$ mm) can be varied in the range of 2 - 25 camera pixels per display pixel, depending on the display pixel pitch and the objective lens, with typical settings in the range of 3 camera pixels per display pixel.

The working distance can be adjusted between ~200 mm and ~900 mm, with typical values in the range above 500 mm.

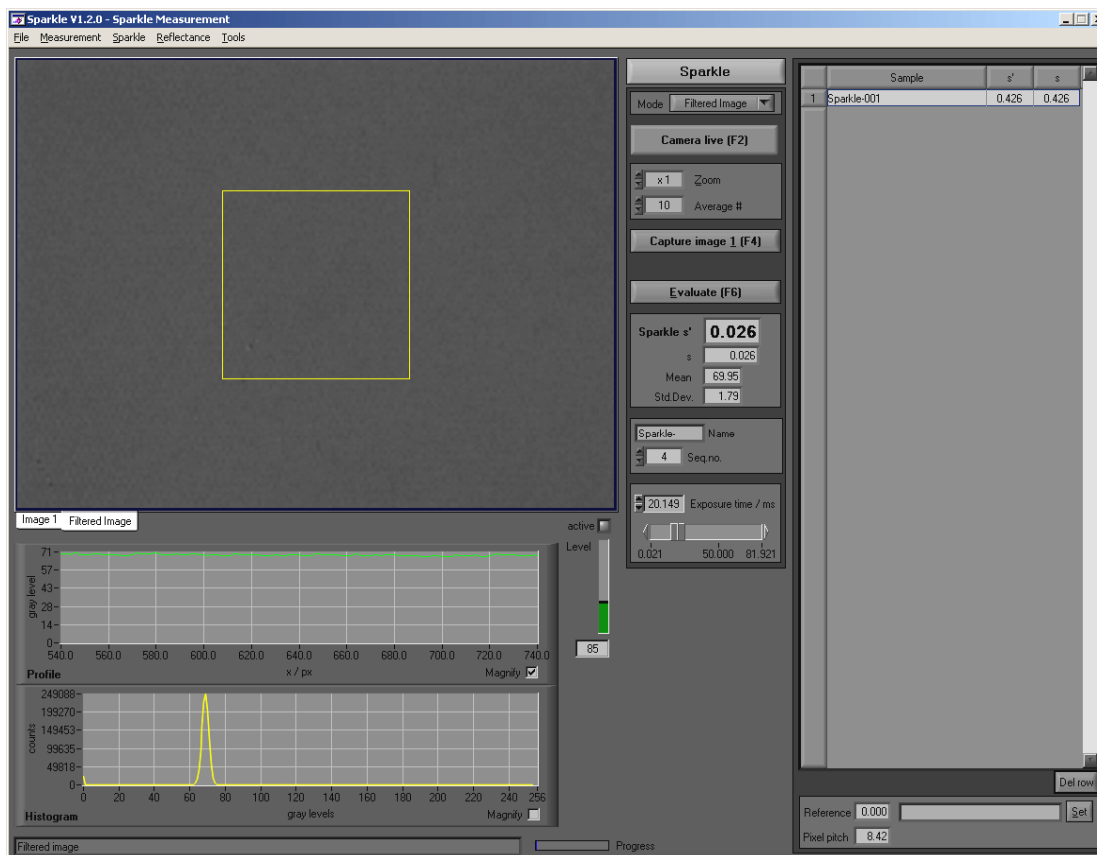

SMS-1000: Sparkle evaluation screen

with the region of interest (ROI) shown as yellow square in the acquired image, intensity profile across the ROI (green curve) and the corresponding intensity histogram (yellow curve). The controls for camera and measurement are located in the center column of the screen, a listing of the measurement results are shown in the rightmost column.

Reflectance Distribution Function – Scattering

A reduction of unwanted reflections on display screens causing discomfort or disability glare is achieved by scattering of light out of the specular direction by micro-structured AG-surfaces.

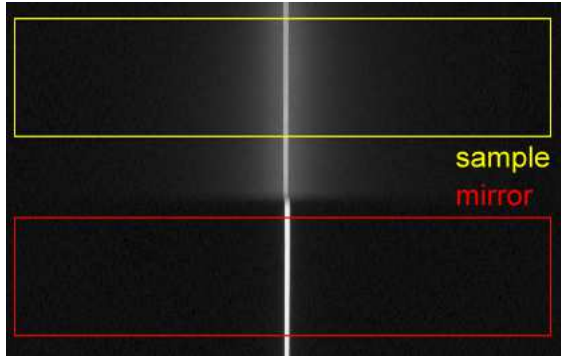

Lateral distribution of reflected light.

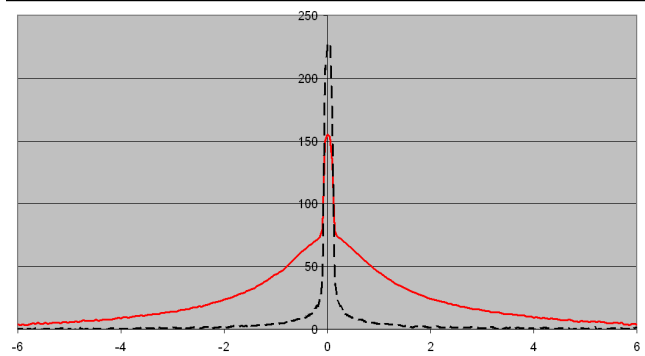

Directional distribution of reflected light.

The intensity of scattered light vs. angle of reflection (i.e. the **reflectance distribution function**, RDF) is an important figure for characterization of AG-layers. The SMS-1000 uses a unique approach for measurement of the **reflectance distribution function** (RDF) over an angular range of up to $\pm 10^\circ$ without moving parts (i.e. no mechanical scanning involved, see JSID13, 1, 2005, pp 81-89)) with high angular resolution. The isotropic linear light source required for this method is integrated in the measurement head of the SMS-1000.

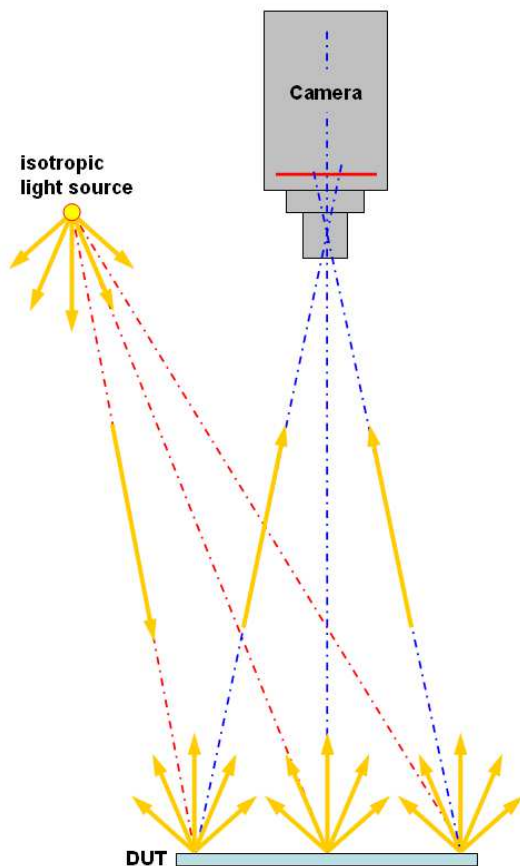

Basic arrangement for measurement of the reflectance distribution function with the SMS-1000 without moving parts.

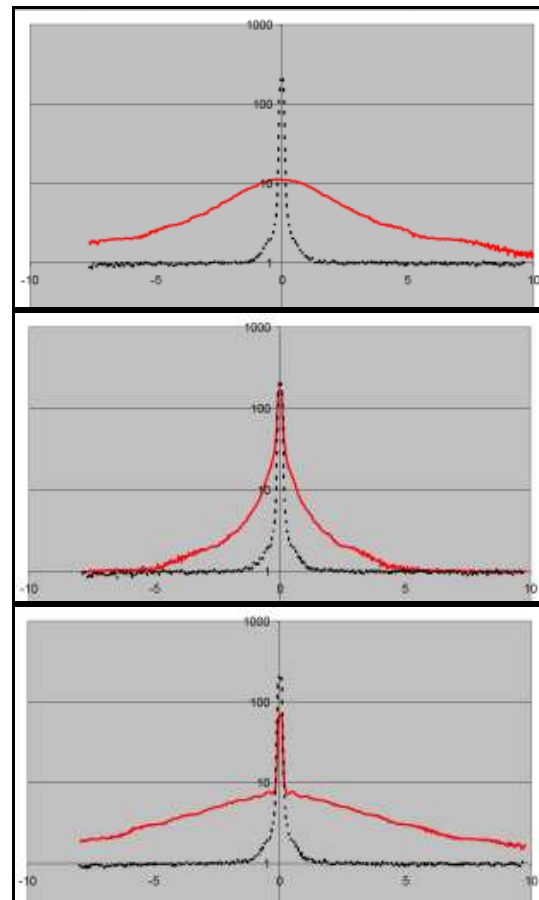

Reflectance Distribution Functions (RDF) for different types of AG-coatings (red curves) with RDF of a reference mirror (black curves).

Transmittance Distribution Function – Scattering

In analogy to the scattering function of the AG-layer in the reflective mode of operation the SMS-1000 can also measure the scattering distribution in transmissive mode of operation without moving parts. An area source is covered with a slit mask to form an isotropic line source that illuminates the transmissive sample from below. From the lateral distribution of light transmission across the uniform sample area the SMS-1000 calculates the angular distribution just as in the reflective case.

From the transmittance distribution function a range of appearance characteristics can be obtained, e.g. the reduction of transmittance in the regular direction, haze (ASTM D1003), distinctness of image, clarity (e.g. ASTM D1746: Transparency of Plastic Sheeting) and others.

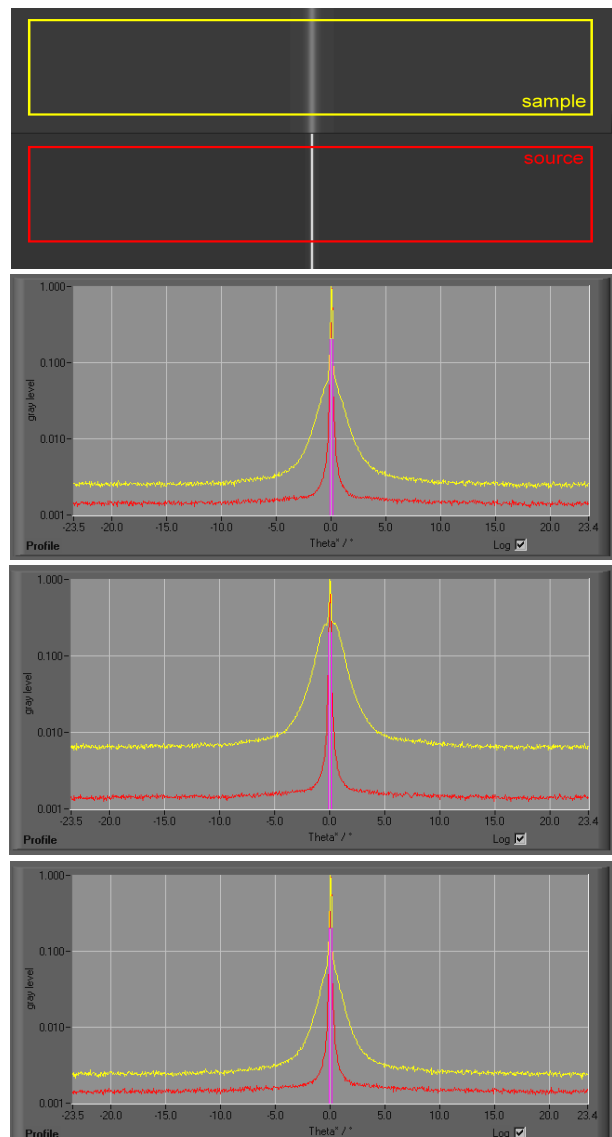
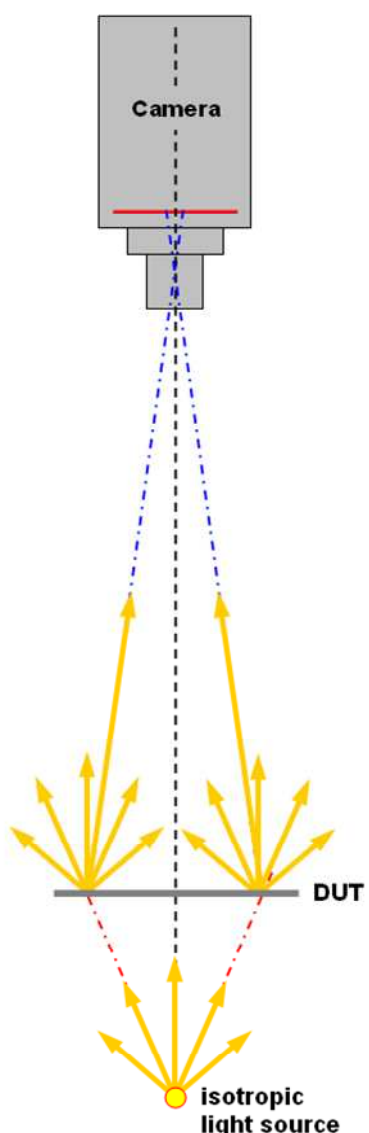

Basic arrangement for measurement of the transmittance distribution function with the SMS-1000. The linear light source is on the base plate of the SMS-1000 stand. The distance of the sample from the light source and from the objective lens determines the angular range covered by the measurement.

Recorded lateral intensity distribution of scattering sample and bare light source and normalized transmittance distribution functions (with logarithmic scaling) of AG-samples with different scattering properties (yellow curves) together with the light source (red curves).

Distinctness of Image - Image Clarity

Scattering of light by micro-structured surfaces does not only reduce specular reflections, it also affects the distinctness (definition, clarity) of images shown on the display screen.

It is of vital importance for the visual performance of a display to realize the reduction of reflections without sacrificing the resolution (distinctness, clarity) of the image.

The distinctness of image is described by the SMS-1000 as a modulation transfer factor (MTF) for each spatial frequency of the pixel pattern with the reference given by the pixel matrix of the display without anti-glare layer, M_0 (see e.g. Eqn. 3 in ASTM D 5767).

$$MTF = M_{AG} / M_0 @ f_{\text{pixel}}$$

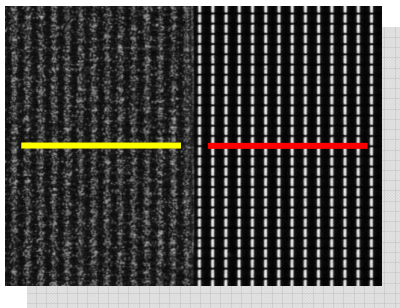

Reduction of distinctness of image by the AG-layer (left)

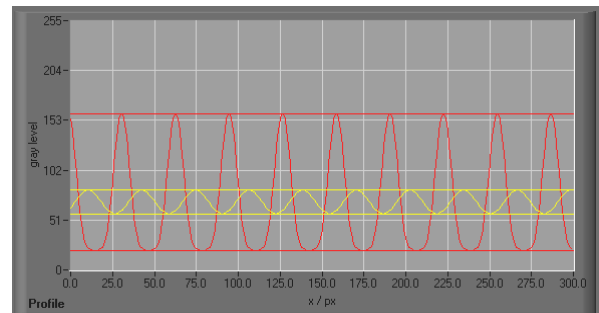

Modulation of transmittance without (red curve) and with AG-layer (yellow curve).

Sample	DOI-smp	DOI-ref
1 DOI-001	0.175	0.778

Graphical user interface of the DOI evaluation of the SMS-1000 with the original pixel matrix (left, yellow ROI) and the pixel matrix with scattering AG-layer (right, red ROI).

System setup and components

A rugged camera stand carries the object of measurement (e.g. display screen with AG-glass) and provides continuous adjustment of the working distance of an electronic camera with a high resolution black/white CCD sensor array. An objective lens with $f = 50\text{ mm}$ focal length is used as standard optics. Other lenses for higher sampling rates (up to 1:1) and small aperture angles (up to F#22) are available on request.

For measurements of reflection scattering, a linear lamp is integrated in the optical head behind a slit aperture with a width of 1 mm.

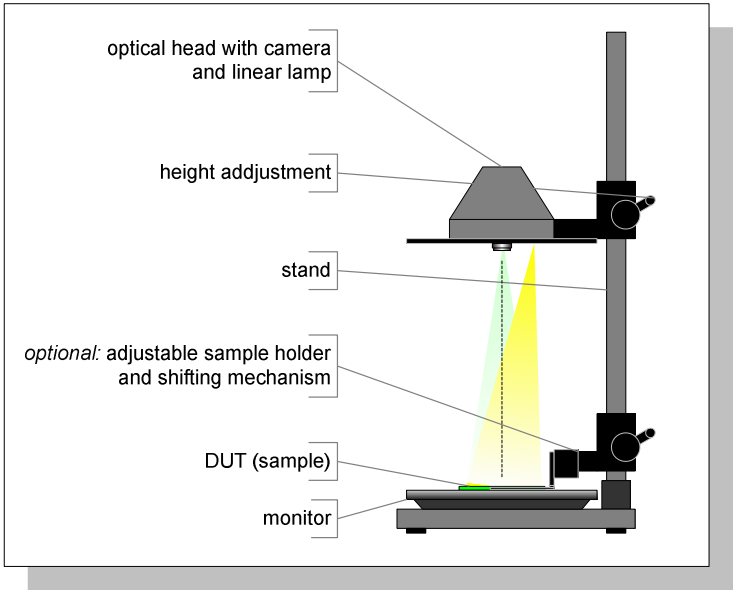

Instead of an LCD screen, a back-illuminated metal mask can be used for fast and convenient evaluation of the effect of display pixel pitch on the level of sparkle. The metal mask target that is optionally available features the following pixel pitches: 300 μm , 250 μm , 200 μm , 150 μm , 100 μm and 50 μm . Other pixel pitches and shapes (e.g. chevron) are available on request.

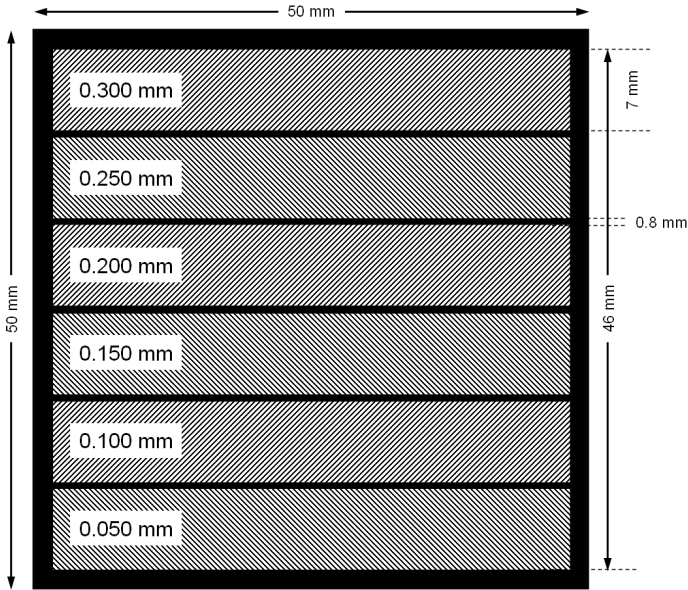

Layout and dimensions of the *pixel pattern matrix*, realized by a precision etched metal layer on a glass substrate.

Microscope head

The optional microscope head is provided for detailed photometric analysis of small features, i. e. picture elements (pixels) and sub-pixels of display devices, for example, for evaluation of "pixel crosstalk".

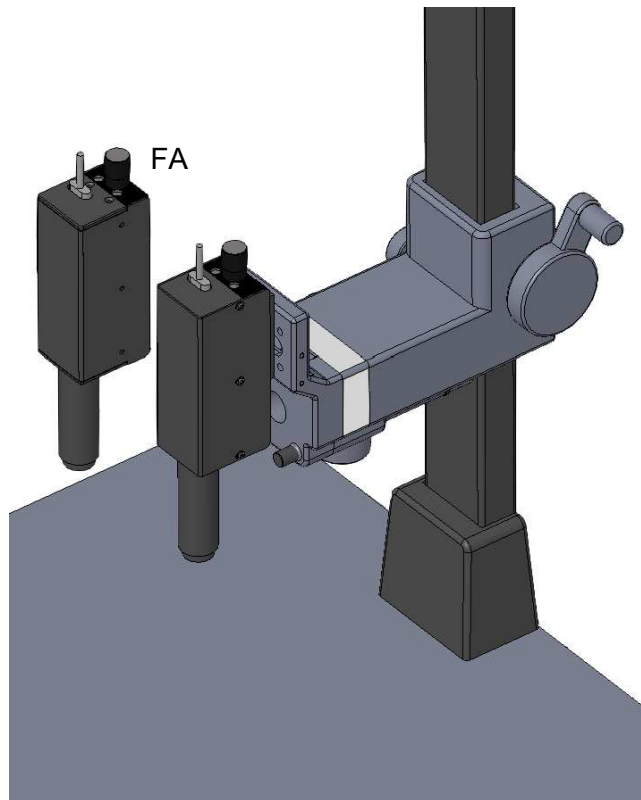

Microscope head (accessory for the SMS-1000) with a robust arm that can be attached to the vertical guide column replacing the standard measurement head. It comprises a translational stage with fine adjustment, a photometric camera and a variety of objective lenses with an imaging ratio of 1:2 or 1:4.

Reference wedge

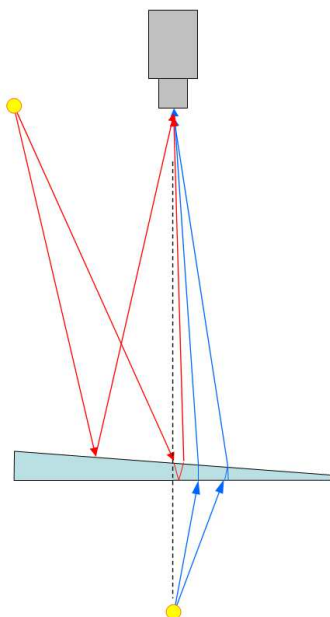

A rectangular wedge made of solid glass (wedge angle 3°) is provided as a reference sample for transmissive and reflective measurements. This reference provides a fast check for the instrument settings to ensure that the resulting angular scaling is correct.

Transmissive case

The wedge effects an angular shift of the regular transmission component of the linear light source by an angle of 1.684° . The angular difference between the first and the second transmitted component is 9.19° , their intensity ratio is $\sim 0.18\%$.

Reflective case

Two reflection components are provided from the wedge: the front surface reflection and a second component reflected from the rear surface of the wedge. The angular difference between both components is between 9.121° and 9.136° for the range of angles of incidence relevant for the SMS-1000 (max. 6°).

Technical Data

Camera	
sensor type / size	CCD, 1/3", 3.75 µm pixel pitch
array dimensions [pixel]	1280 x 960
AD conversion	8 / 12 bit
Dynamical range (HRDI mode)	> 10 ⁺⁴
interface	IEEE 1394 ("fire wire")
Objective lens	
focal length	50 mm (optional 16 mm / 25 mm)
maximum aperture	F#2.8
typical operating aperture (F#)	F#2.8 for DOI measurements, ≥ F#8 for sparkle measurements
other lenses are available on request	f = 100 mm @ 1:1 imaging, f = 25 / 16 mm
Lamp for reflectance measurements	
lamp type	white light CCFL
aperture slit width	1 mm
angular subtense (@ 500 mm working distance)	0.06°
Dimensions and mass (approximate values)	
width	600 mm
depth	500 mm
height	1055 mm (max. ca. 1200 mm)
mass	17 kg

Order options

Item	Description
SMS-1000 comprising	Basic turnkey system for sparkle evaluation comprising measurement stand, computer and lens f = 50 mm.
Evaluation of reflectance distributions	Evaluation of Reflectance Distribution Functions comprising a linear light-source, a specular reflectance standard and software, objective lens f = 16 mm for extended angular range (±10°).
Evaluation of DOI / MTF	Evaluation of Distinctness of (transmitted) Image via the Modulation Transfer Factor (software only).
Evaluation of transmittance distributions	Evaluation of Transmittance Distribution Functions comprising a set of slit apertures and software. The data can be evaluated to yield DOI in transmittance, transparency, clarity, optical crosstalk, etc.
Accessory 1 Pixel Matrix Target	Pixel-Matrix-Target 50 mm x 50 mm (metal layer on glass) with 6 pixel-pitch dimensions: 0.050 mm, 0.100 mm, 0.150 mm, 0.200 mm, .250 mm and 0.300 mm.
Accessory 2 Areal Light Source	LED area light source with power supply for illumination of pixel matrix target and/or slit aperture.
Accessory 3 Microscope Head	for detailed photometric analysis of small features (pixels, subpixels)

Display-Messtechnik&Systeme ♦ Lenaustr. 3 ♦ D-72108 Rottenburg am Neckar ♦ Germany

www.display-messtechnik.de - mail@display-messtechnik.de

